

# Fireproof Solutions

## Safety Systems



Reynaers  
Aluminium

Windows.  
Doors.  
Curtain Walls.

Together for better

[www.reynaers.com](http://www.reynaers.com)

# Denser urbanisation means increased safety requirements





# Fire resistant windows, doors and façades play a key role in mitigating harm to people and damage to property in case a fire breaks out in a building.

Certified fireproof joinery prevents indoor fires from spreading for a given amount of time. These precious minutes allow people to evacuate buildings safely, while helping fire fighters arrive on the scene in time. Due to dense urbanisation, creating safe living spaces in cities has become an important topic. And when the number of high-rise towers keeps on growing, so does the risk of major fire disasters.

At Reynaers Aluminium, we face rising urbanisation levels head-on, by developing high-quality systems for residential projects, office buildings and public buildings that accommodate sports, arts, culture, or infrastructure. At the same time, we contribute to efficient building processes and offer pre-fabricated modules on-site. All our solutions heavily focus on comfort, design and sustainability, as we build a healthier and safer future together.

# Introduction into fire resistance

Agrokoncernas, Lithuania — Architect: Audrius Ambrasas Architects — Photographer: UAB 'Structum' - ConceptSystem 77-FP

Before a product can be labelled fire resistant it has to undergo rigorous testing. Real size elements are installed in an oven and heated up to temperatures simulating a fully developed fire, well beyond the melting point of aluminium.

During the test data is recorded on surface temperature, heat radiation and deflection of the construction. These parameters will determine the classification.

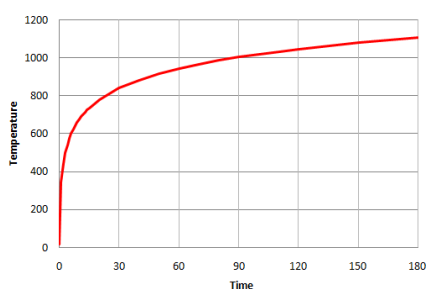

Thermocouples installed all over the test element monitor the surface temperature increase.



In the first minutes of the fire the protective layer in the glass reacts and turns opaque. This blocks the heat and helps to reduce panic by obscuring the flames from view.



For the duration of the test nothing may ignite on the protected side. The testing officer makes sure of this by holding a cotton pad in critical areas.



The test is ended after integrity is lost and flames pass through. The fire exposed side can be seen to be charred and molten.

# Classification breakdown

General hierarchy of classifications is EI > EW > E:

- "EI" classified products can be used when "EI", "EW" or "E" is required
- "EW" classified products can be used when "EW" or "E" is required.
- "E" is the most basic classification

Example: EW 30 classified products can be used where EW 30 or E 30 is required, but not when EI 30 is required.

## E

### Integrity

Criteria:

- No sustained flaming ( $\geq 10s$ )
- No openings
- No ignition of cotton pad



No flames through element

## I

### Thermal Insulation

Criteria:

- Average temperature increase  $< 140K$
- Maximum temperature increase  $< 180K^*$
- No ignition of cotton pad

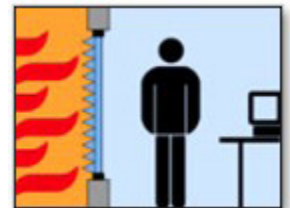

No propagation of fire through contact with hot surfaces

## 1

*\*For doors and openable windows there is a distinction between  $I_1$  and  $I_2$*

- $I_1$  –  $\geq$  max. temp. increase  $< 180K$  anywhere on the element, extra measurement points on opening part (only obligated in Belgium and Luxembourg)

## 2

- $I_2$  –  $\geq$  max. temp. increase  $< 360K$  on frame surrounding opening part, anywhere else  $< 180K$

## W

### Radiation

Criteria:

- Radiation  $< 15 kW/m^2$

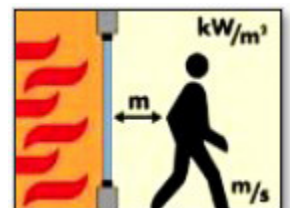

No propagation of fire through radiation from surfaces

## tt

### Duration

Criteria:

- Round down the successfully tested time to the nearest class.
- Short: 10-15-20 min
- Medium: **30-45-60-90 min (= most common)**
- Long: 120-180-240-360 min



# Overview of our Fireproof products

## External Doors C € / Internal Doors

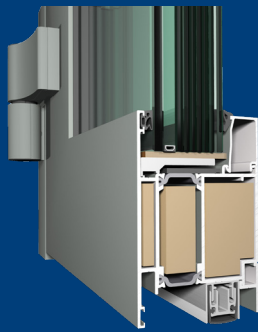

ConceptSystem 77-FP

FIREPROOF CLASSES   EN 13501-2			
EW 30	EI <sub>1</sub> 30	EI <sub>2</sub> 30	EI <sub>2</sub> 30-S200
	EI <sub>1</sub> 60	EI <sub>2</sub> 60	EI <sub>2</sub> 60-S200



MasterLine 8-FP

FIREPROOF CLASSES   EN 13501-2	
EW 30	EI <sub>2</sub> 30



FlameLine

FIREPROOF CLASSES   EN 13501-2	
EI <sub>1</sub> 30	EI <sub>2</sub> 30
EI <sub>1</sub> 60	EI <sub>2</sub> 60

Performances and properties of our safety products depend on size, profile combinations, hardware and infill choices. Additionally, local approvals and regulations may change the values listed in this document. Please contact your local Reynaers Aluminium representative for guidance.

# Opening Windows



ConceptSystem 77-FP

FIREPROOF CLASSES   EN 13501-2	
EW 30	EI <sub>2</sub> 30

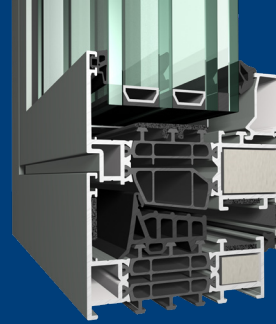

MasterLine 8-FP

FIREPROOF CLASSES   EN 13501-2		
EW 30	EI <sub>1</sub> 30	EI <sub>2</sub> 30

## External fixed glazing / Internal partition walls



ConceptSystem 77-FP

FIREPROOF CLASSES   EN 13501-2	
EW 30	EI 30
EW 60	EI 60

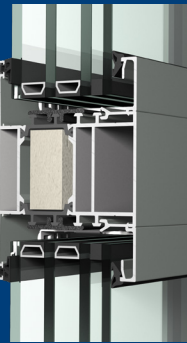

MasterLine 8-FP

FIREPROOF CLASSES   EN 13501-2	
	EI 30

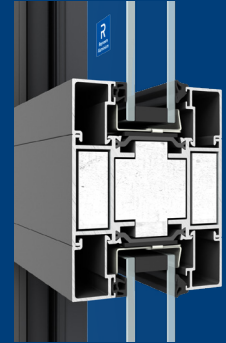

FlameLine

FIREPROOF CLASSES   EN 13501-2	
	EI 60

## Façades

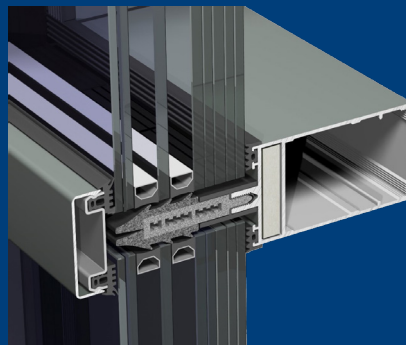

ConceptWall 50-FP

FIREPROOF CLASSES   EN 13501-2	
EW 30	EI 30
	EI 60

# ConceptSystem 77 Fireproof (FP)

## FIREPROOF CLASSES | EN 13501-2



External Door



Internal Door

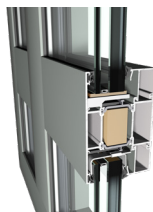

Partition Wall



Opening Window

EI<sub>1</sub> 30  
EI<sub>2</sub> 30

EI<sub>1</sub> 30  
EI<sub>2</sub> 30

EW 30  
EI 30

EW 30

EI<sub>2</sub> 30

EW 60  
EI 60

EI<sub>1</sub> 60  
EI<sub>2</sub> 60

EI<sub>1</sub> 60  
EI<sub>2</sub> 60



# Our most complete range of fireproof solutions

Extensively tested in various laboratories across Europe, CS 77-FP has been a reference in the market for many years. Full compliance with CE-marking according to EN 16034 as well as various national approvals mean that the product is widely accepted for application on the interior as well as on the exterior of the building.

CS 77-FP delivers up to 60 minutes of fire resistance along with all the benefits of our CS 77 system: thoroughly tested, a wide range of possibilities and a uniform way of working for all types of elements.

A wide range of tested glass and hardware types offers maximum flexibility and operational efficiency.

# ConceptSystem 77-FP

## Doors



CS 77-FP doors are available with 30 or 60 minute fire resistance along with all the benefits of our CS 77 system: thoroughly tested, a wide range of possibilities and a uniform way of working for all types of doors.

Design options include various hinge types, design handles and a concealed door closer. The various bottom solutions offer a tailored solution for the specific end-use condition, whether accessibility, water tightness or elimination of draft is of primary importance.

Single and double doors as well as configurations with top- or sidelights are possible in internal or external applications.



**CE** according to EN 16034 + EN 14351-1 (only for external doors)

PERFORMANCES / PROPERTIES		FIREPROOF CLASSES   EN 13501-2			
		EI <sub>2</sub> 30	EI <sub>2</sub> 60	EI <sub>1</sub> 30	EI <sub>1</sub> 60
Performances	Thermal insulation	Uf ≥ 3.2W/m²K	Uf ≥ 3.6W/m²K	Uf ≥ 3.6W/m²K	Uf ≥ 3.6W/m²K
	Burglarproof			RC2	
	Max vent weight			250 kg	
	Visible width vent-frame			150 mm	
	Frame depth			68 mm	
	Vent depth			68 mm	
	Thickness			13 - 52 mm	
Glass	Monolithic I			■	
	Double II			■	
	Triple III	■	-	■	-
Hinges	Rollenband	■	■	■	-
	Türband			■	
Threshold solutions	Drop seal			■	
	Gasket			■	
	Brush			■	

Available options:



Anti-Panic



Burglarproof RC2



Low Threshold



Zero Threshold



As per requirement in the European Union, the doors for external application can be **CE-marked**. Internal doors might need local approval, please contact your Reynaers representative for more information.

Our fireproof doors can also be **smokeproof**. Inhalation of toxic fumes can be lethal and is statistically the primary cause of fatality in a fire. Furthermore smoke development limits visibility and may complicate evacuation.

Doors with the classification Sa or S200 (EN 13501-2) have been proven to be sufficiently air tight to effectively limit the spread of smoke under ambient (room) temperature or 200°C respectively.

CS 77-FP doors can meet both classifications with only a few additional measures.

#### FIRE- AND SMOKEPROOF CLASSES | EN 13501-2

PERFORMANCES / PROPERTIES		EI <sub>2</sub> 30-S200	EI <sub>2</sub> 60-S200
Performances	Thermal insulation	Uf ≥ 3.2W/m²K	Uf ≥ 3.6W/m²K
	Burglarproof		RC2
	Max vent weight		250 kg
	Visible width vent-frame		150 mm
	Frame depth		68 mm
	Vent depth		68 mm
	Thickness		13 - 52 mm
Glass	Monolithic I		■
	Double II		■
	Triple III	■	-
Hinges	Rollenband		-
	Türband		■
Threshold solutions	Drop seal		■
	Gasket		-
	Brush		-

# ConceptSystem 77-FP

## Openable Windows



CS 77-FP openable windows offer a solution to create a fire resistant yet openable glazed enclosure.

Having achieved EW 30 and EI2 30 performance and being certified for CE-marking mean that it is widely applicable in Europe.

Various hardware options allow the creation of turn, tilt, turn-tilt and tilt before turn opening types, with the choice of visible or concealed hinges. Lockable handles are available in different designs.



**CE** according to EN 16034 + EN 14351-1



Musa — Architect: diederindrix architecten — Photographer: Arthur Bogen — ConceptSystem 77-FP

**FIREPROOF CLASSES | EN 13501-2**

PROPERTIES		EW 30	EI <sub>2</sub> 30
Performances	Thermal insulation	Uf ≥ 2.4W/m²K	
	Burglarproof	RC 2 N	
Dimensions	Max element height	3000 mm	
	Max vent weight	170 kg	
	Visible width vent-frame	115 mm	
	Frame depth	68 mm	
	Vent depth	77 mm	
	Thickness	13 - 52 mm	
Glass	Monolithic I	■	-
	Double II		■
	Triple III		■

Available options:



Burglarproof  
RC2 N



Concealed  
Hinges



# ConceptSystem 77-FP

## Partition walls / Fixed Windows

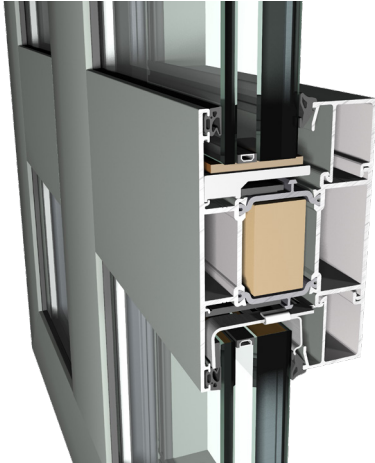

ConceptSystem 77-FP allows creation of fire resistant glazed partition walls as well as external fixed windows in the classes EW 30, EI 30, EW 60 or EI 60 with a variety of glass types.

CS 77-FP doors and windows with the same or lower fire rating can be integrated, according to the requirements.

Optionally the glass panels can be joined vertically without members, with the use of Vetrotech Contraflam Structure glazing.

### FIREPROOF CLASSES | EN 13501-2

PROPERTIES		EW 30	EI 30	EW 60	EI 60
Max height		4.25m	4.4m	3.65m	3.85m
Performances	Thermal insulation	Uf ≥ 3.6W/m²K			
	Min visible width T-profile	102 mm			
	Frame depth	68 mm			
	Thickness	13 - 52 mm			
	Monolithic		■		
Glass	Double II			■	
	Triple III	■	■	-	-
	Tested with...	Vetrotech - Pyroguard	Vetrotech - Pyroguard - AGC - Pilkington	Pyroguard	Vetrotech - Pyroguard - AGC - Pilkington



Available options:



Burglarproof  
RC2



Glass  
Corner

# MasterLine 8 Fireproof (FP)

BUSINESS LOUNGE

## FIREPROOF CLASSES | EN 13501-2



External Door

EW 30

EI<sub>2</sub> 30



Internal Door

EI<sub>2</sub> 30

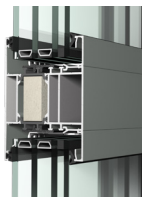

Partition Wall

EI 30



Opening Window

EW 30

EI<sub>1</sub> 30  
EI<sub>2</sub> 30



# Expanding our future proof platform even further

Based on the well-known MasterLine 8 windows and doors platform, this system variant enables the production of fire resistant elements within a familiar workflow.

The profile design allows for fast assembly and a wide range of glass and hardware options are included in the classification.

MasterLine 8-FP is suitable for both internal and external elements, with CE-marking possible for external doors.

# MasterLine 8-FP

## Doors



MasterLine 8-FP doors offer the same performance and functionality as standard MasterLine 8 doors, along with 30 minutes fire resistance. Visually you can tell the difference only by opening the door, by the intumescent gasket that is neatly attached to the insulation strip.

Also in assembly the differences are minimal, so fabricators familiar with MasterLine 8 will quickly be accustomed to the production of fire proof elements. As per requirement in the European Union, the doors for external application can be CE-marked. Internal doors might need local approval, please contact your Reynaers representative for more information.



according to EN 16034 + EN 14351-1 (only for external doors)

PERFORMANCES / PROPERTIES		FIREPROOF CLASSES   EN 13501-2	
		EW 30	EI <sub>2</sub> 30
Performances	Thermal insulation		Uf ≥ 2.3W/m²K
	Burglarproof	RC2 N	RC2
Dimensions	Max element height		4200 mm
	Max vent weight		250 kg
	Visible width vent-frame		153 mm
	Frame depth		77 mm
	Vent depth		77 mm
	Thickness		15 - 61 mm
Glass	Monolithic I	-	■
	Double II		■
	Triple III		■
Hinges	Rollenband		■
	Türband		■
Threshold solutions	Drop seal		■
	Gasket		■
	Brush		■

Available options:



Anti-Panic



Burglarproof RC2 (N)



Low Threshold



Zero Threshold



# MasterLine 8-FP

## Partition walls / Fixed Windows

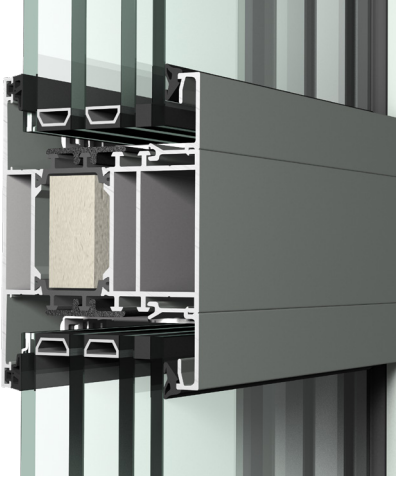

MasterLine 8-FP allows creation of fire resistant glazed partition walls as well as external fixed windows in the class EI 30 with a variety of glass types. MasterLine 8-FP doors and windows with the same or lower fire rating can be integrated, according to the requirements.

### FIREPROOF CLASSES | EN 13501-2

#### PROPERTIES

## EI 30

Max height

4.2m

Performances

Thermal insulation

$U_f \geq 2.2W/m^2K$

Min visible width T-profile

104 mm

Frame depth

77 mm

Thickness

15 - 61 mm

Glass

Monolithic |



Double ||



Triple |||





# MasterLine 8-FP

## Openable Windows

MasterLine 8-FP openable windows combines fireproof protection in openable elements. Its EW 30, EI<sub>1</sub> 30 and EI<sub>2</sub> 30 fireproof classes, together with the CE certification, are a testimony to the system's thoroughly tested-and-verified performance.

With the help of the versatile hardware options, you can create turn, tilt, turn-tilt, tilt before turn, double casement turn-turn, double casement turn-tilt-turn, and double casement tilt-turn-turn opening types, all with concealed hinges. For additional safety, lockable handles are available in different designs.

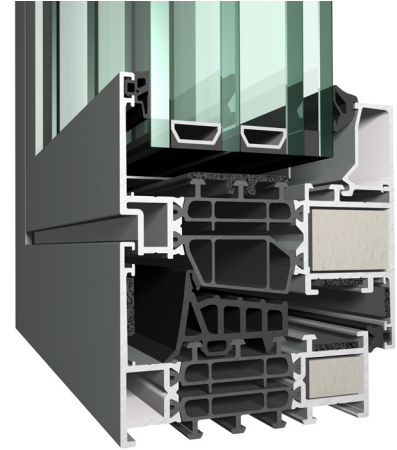

**CE** according to EN 16034 + EN 14351-1

PROPERTIES		FIREPROOF CLASSES   EN 13501-2		
		EW 30	EI <sub>1</sub> 30	EI <sub>2</sub> 30
Performances	Thermal insulation		U <sub>f</sub> ≥ 1.8 W/m <sup>2</sup> K	
	Burglarproof		RC 2 N	
Dimensions	Max element height		3500 mm	
	Max vent height		2540 mm	
	Max vent weight		200 kg	
	Visible width vent-frame		97 mm	
	Frame depth		77 mm	
	Vent depth		87 mm	
Glass	Thickness		31 - 61 mm	
	Double II	■	■	■
	Triple III	■	■	■

Available options:



Burglarproof  
RC2 N



Concealed  
Hinges



**R**  
Reynaers  
Aluminium

Fireproof testing of MasterLine 8-FP Opening Windows.

# FlameLine



**FIREPROOF CLASSES | EN 13501-2**



External Door



Internal Door



Partition Wall

EI<sub>1</sub> 30

EI<sub>2</sub> 30

EI<sub>1</sub> 60

EI<sub>2</sub> 60

EI<sub>1</sub> 30

EI<sub>2</sub> 30

EI<sub>1</sub> 60

EI<sub>2</sub> 60

EI 60

# Our dedicated fireproof platform

FlameLine is the latest addition to our fireproof offer. The versatile solution allows nearly all glass type combinations to meet the complex requirements linked to fail-safe escape doors, such as fire retarding properties, burglar resistance, emergency evacuation and superior thermal insulation with triple glazing.

FlameLine doors and partition walls have been tested to full CE-mark compliance according to EN 16034 with different glass suppliers in different European labs. What is more, FlameLine offers fire protection for 30 and 60 minutes, for doors both to class E1 and class E2. Nothing is left to chance.

The system's modular and symmetrical design enables efficient assembly and stock management, reducing the total amount of articles. It is an ideal solution for industrial production, when components need to be bought in larger quantities.



# FlameLine

## Doors



FlameLine internal and external doors are available for 30 and 60 minute fire resistance. The system's symmetrical build-up allows for centrally positioned single glass units in case of internal doors.

Rebated door profiles are available to allow for EI 60 compliance. Triple glazing up to 69mm can be installed for external applications. Single or double, inward or outward opening doors, with top and/or side lights: the choice is yours.



according to EN 16034 + EN 14351-1 (only for external doors)

PERFORMANCES / PROPERTIES		FIREPROOF CLASSES   EN 13501-2			
		EI <sub>2</sub> 30	EI <sub>2</sub> 60	EI <sub>1</sub> 30	EI <sub>1</sub> 60
Performances	Thermal insulation	Uf ≥ 2.2W/m²K	Uf ≥ 2.2W/m²K	Uf ≥ 2.2W/m²K	Uf ≥ 2.8W/m²K
	Water tightness			E900 (900Pa)	
	Wind load resistance			C4 (1600Pa)	
	Air tightness			3 (600Pa)	
	Burglarproof			RC2	
Dimensions	Acoustic insulation			43 (-1;-3) dB	
	Max vent weight			250 kg	
	Visible width vent-frame			154.5 mm	
	Frame depth			85 mm	
Glass	Vent depth			85 mm	
	Thickness			25 - 69 mm	
	Monolithic I			■	
	Double II			■	
Hinges	Triple III			■	
	Dr. Hahn TB IV AT			■	
	LOIRA +			■	
Threshold solutions	WALA WX			■	
	18mm threshold			■	
	Automatic draft excluder			■	
	Brush			■	

Available options:



High insulation



Zero threshold



Low Threshold



Burglarproof RC2



# FlameLine

## Partition walls / Fixed Windows

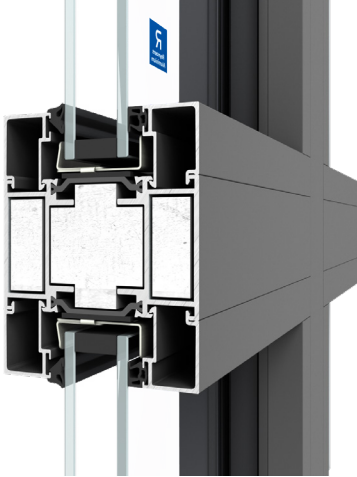

FlameLine can be used to create fire resistant glazed partition walls as well as external fixed windows in class EI 60.

The same symmetrical profiles of the door frames and vents can be used for centrally positioned single glass units in case of internal partitioning.

Rebated frames or T-profiles are available to allow for EI 60 compliance. Triple glazing up to 69mm can be installed for external applications.

### FIREPROOF CLASSES | EN 13501-2

#### PROPERTIES

#### EI 60

Performances	Thermal insulation	$U_f \geq 2.0 \text{ W/m}^2\text{K}$
	Water tightness	E1050 (1050Pa)
	Wind load resistance	C4 (1600Pa)
	Air tightness	4 (600Pa)
	Burglarproof	RC2
Dimensions	Max. height	3380 mm
	Max. weight	400 kg
	Min. visible width T-profile	106 mm
	Frame depth	85 mm
Glass	Thickness	25 - 69 mm
	Monolithic	■
	Double	■
	Triple	■

Available options:



Burglarproof  
RC2

# ConceptWall 50 Fireproof (FP)

**FIREPROOF CLASSES | EN 13501-2**

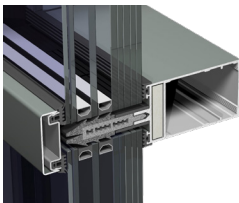

Mullion Transom

EW 30

EI 30

EI 60



# Safe and comfortable façade solutions

Transparency, insulation and fire protection come together in our recently updated ConceptWall 50-FP façade system.

The system design enables very large and heavy glass panels up to 550 kilograms.

Thermal comfort and energy savings are not compromised: triple glazing and insulation foams were tested and may be used to achieve very low U-values.

ConceptWall 50-FP is fire tested from inside to outside as well as from outside to inside and can be installed in front and in between floor slabs.



# ConceptWall 50-FP

## Façade

The fireproof variant of our most versatile façade solution, ConceptWall 50-FP is fire tested both from the inside to the outside and from the outside to the inside, according to the full (internal) fire curve. As a result, the system is suitable for the most stringent regulations and can be applied as a partition wall too. Available fireproof classes are EW 30, EI 30 and EI60 with minimal system differences.

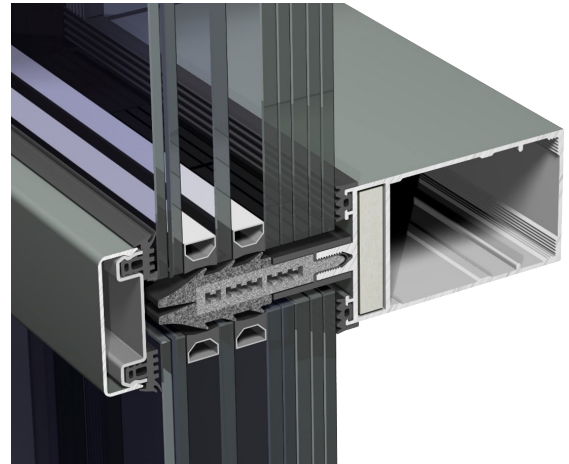

**FIREPROOF CLASSES | EN 13501-2**

PERFORMANCES / PROPERTIES		EW 30	EI 30	EI 60
Performances	Thermal insulation (HI variant)		$U_f \geq 0.8W/m^2K$	
Dimensions	Mullion Depth		83 - 167.5 mm	
	Visible Width		50 mm	
Inclination	Vertical façade		■	
	Maximum Inclination		+/- 10°	
	Thickness		34 - 78 mm	
	Max Glass Weight	Up to 700 kg	Up to 700 kg	Up to 550 kg
Glass	Glass Suppliers	Pyroguard	Vetrotech, AGC, Pyroguard, Polflam	Vetrotech, AGC, Pyroguard, Polflam
	Monolithic I		-	
	Double II		■	
	Triple III		■	

Available options:



High Insulation



# Tested with a great variety of fire resistant glass



For fire resistance, the profiles and the glass can not be evaluated separately from each other. As the performance depends on the interaction between both, classifications are only valid for the tested combination.

Fire resistant glass for EI classification typically consists of two or more panes of glass with a clear interlayer, which reacts in case of a fire forming an insulating barrier against the heat.

There are float and tempered types out there. Float glass can be cut to size for shorter lead times while tempered glass is stronger, more stable and allows bigger dimensions. Both are possible also as double- or triple glass units for improved energy, comfort & safety levels.

We tested many variations of our profiles with the most internationally available glass suppliers in the industry, including different glass compositions. This enables flexibility in application without compromising the safety, quality and design freedom within your project.

*This is a simplified overview and does not give conclusive information. For full details and limitations, consult the relevant approval or contact your Reynaers Aluminium representative.*

M	Monolithic (single) glass
D	Double glass
T	Triple glass
Te	Tempered glass
Cu	Cuttable glass







**FIREPROOF CLASSES | EN 13501-2**

MasterLine 8-FP





ConceptSystem 77-FP

FlameLine 60

Manufacturer	Type		MasterLine 8-FP			ConceptSystem 77-FP			FlameLine 60	
			Door	Partition Wall	Opening Window	Door	Partition Wall	Opening Window	Door	Partition Wall
	Contraflam Lite 30	Te	DT		DT		MD	MD		
	Contraflam 30	Te	MDT	MDT	DT	MDT	MDT	DT	MDT	MDT
	Contraflam 60-3	Te				MD	MD		MDT	MDT
	Pyrostop 30	Cu	MDT	MDT		MDT	MD			
	Pyrostop 60	Cu				MD	MD			
	Pyrobel 16 (EG)	Cu				MDT	MD			
	Pyrobel 25 (EG)	Cu				MD	MD			
	Pyrobel-T EI30	Te				MDT				
	Pyrobel-T EI60	Te				MD				
	Pyroguard T-EW30	Te					MDT	DT		
	Pyroguard T-EW60	Te					MD			
	Pyroguard T-EI30	Te	MDT	MDT		MDT	MDT			
	Pyroguard T-EI60	Te				MD	MD			
	Polflam EI 30	Te							MDT	MDT
	Polflam EI 60	Te							MDT	MDT

**FIREPROOF CLASSES | EN 13501-2**

ConceptWall 50-FP

Manufacturer	Type		Stick Façade	
			Door	Partition Wall
	Contraflam Lite 30	Te		
	Contraflam 30	Te		DT
	Contraflam 60-3	Te		DT
	Pyrostop 30	Cu		
	Pyrostop 60	Cu		
	Pyrobel 16 (EG)	Cu		
	Pyrobel 25 (EG)	Cu		
	Pyrobel-T EI30	Te		DT
	Pyrobel-T EI60	Te		DT
	Pyroguard T-EW30	Te		DT
	Pyroguard T-EW60	Te		
	Pyroguard T-EI30	Te		DT
	Pyroguard T-EI60	Te		DT
	Polflam EI 30	Te		DT
	Polflam EI 60	Te		DT

## About us

*"Together we are improving the living and working environment for people now and for future generations."*

As part of Reynaers Group, Reynaers Aluminium is a leading European specialist in the development and marketing of innovative, sustainable aluminium solutions for windows, doors, and façades. Together with our partners, we focus on creating energy-efficient, responsibly made products that make a difference for homes, buildings and the people they serve.

Reynaers Aluminium is founded in 1965 and currently employs over 2,600 workers in more than 40 countries worldwide. The company exports to more than 70 countries on 5 different continents. In 2024, Reynaers Group achieved an annual turnover of 703 million euros.

The company's success is strengthened by our close partnership with 5,000 partner fabricators, architects, and project developers worldwide. This unique cooperation is reflected in our motto: Together for better.

At Reynaers Campus, our headquarters in Belgium, we focus on sharing knowledge and experience with architects, fabricators, contractors and other building partners while inspiring them with new technologies. Next to the Technology, Training and Automation Centre, Reynaers Campus also has its own Experience Centre where future buildings can be explored in our virtual reality room Avalon.

For more information, visit [www.reynaers.com](http://www.reynaers.com)



**Reynaers  
Aluminium**

Oude Liersebaan 266  
B-2570 Duffel

T +32 (0)15 30 88 10  
info@reynaers.com

[www.reynaers.com](http://www.reynaers.com)